

# 8"

## Architectural LED Downlight

# EPD-8-RGBW

## Edison Series

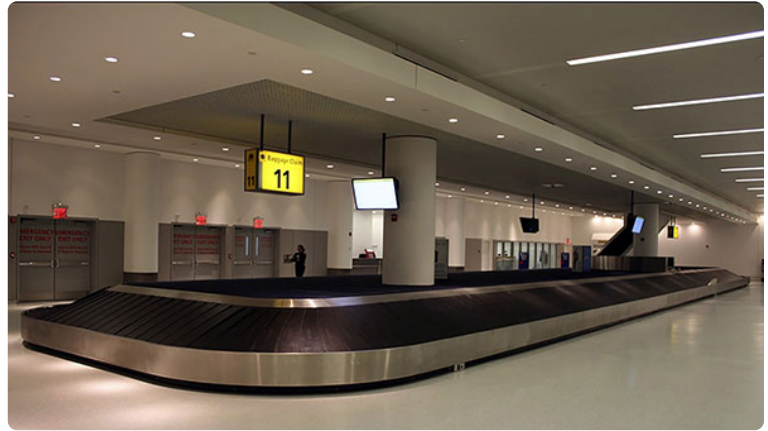
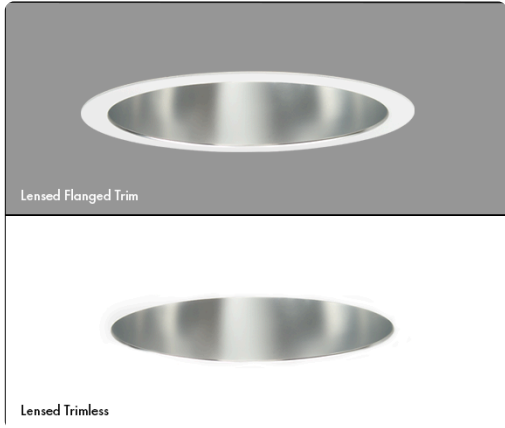

### Application

A complete family of downlights, accent lights, wallwashers, double wallwashers, and corner wallwashers in multiple beam spreads and apertures designed for commercial, civic, museums, corporate, hospitality, academic, retail, medical, and houses of worship.

### Features

- Exceptional Optical Quality: Up to 98 CRI, 1x2 Step MacAdam Ellipse.
- Shipped standard with a Solite Beam Smoother lens that removes striations from the light source.
- Available with a multitude of dimming protocols and control offerings.

Nominal Lumens	Delivered Lumens	Wattage
900L	852	12
1200L	1098	16
1500L	1421	20
2000L	1925	27

Based on 4000K, 90+ CRI with semi-specular chrome reflector. Actual wattage may vary +/-5%

<b>Lumens</b>	<b>Tunable White:</b> 900, 1200, 1500, 2000, 3000, 4000 <b>RGB + White:</b> 1100, 2000
<b>CCT &amp; Dynamic Platforms</b>	<b>Tunable White:</b> 50K-27K, 65K-27K <b>RGB + White:</b> LENGN-65K-18K
<b>CRI</b>	90+
<b>Color Quality</b>	2 Step MacAdam Ellipse
<b>Distributions</b>	NSPD (Narrow Spot 15°), SPD (Spot 24°), ND (Narrow 30°), MD (Medium 36°), MWD (Medium Wide 52°), WD (Wide 60°), VWD (Very Wide 70°)
<b>Trim Options</b>	Downlight, Wall Wash, Double Wall Wash, Corner Wall Wash, Wet Location
<b>Reflector Colors</b>	CL (Semi-Specular Chrome), SHZ (Low Iridescent Satin Haze), WT (Wheat), W (White), BK (Black), BZ (Bronze)
<b>Flange Colors</b>	TL (Trimless), WH (Self-Flanged White), SCH (Self-Flanged Semi-Specular Chrome), SHZ (Self-Flanged Low Iridescent Satin Haze), BK (Self-Flanged Black), BZ (Self-Flanged Bronze)
<b>Dimming</b>	<b>Tunable White:</b> DIM10, DMX-512, DMX-RDM, DALI, BLE, LUTH <b>RGB + White:</b> ELDODMX.1
<b>Emergency</b>	<b>Tunable White:</b> EMG-LED-10W, EMG-LED-20W, INTG-EMG-LED-10W, INTG-EMG-LED-20W, EMG-LED-G2-10W-SDT <b>RGB + White:</b> PELI-S-20, PELI-S-100, PELI-S-250, PELI-S-400
<b>Lifetime</b>	L70 at 102,000 Hours
<b>Photometric Tests</b>	In Accordance with IES LM79-08, LM80 and TM-30, TM-21



# 8"

# EPD-8-RGBW

## Architectural LED Downlight

## Edison Series

PART NUMBER: **EPD-8-TWH-50K-27K-900L-90-NSPD-DIM10-120V**

Series	Technology	Lumen:	CRI	Optics	Driver	Voltage	Emergency	Option	Accessories
<b>EPD-8-TWI</b> <small>(Tunable White)</small>	<b>50K-27K</b> <b>65K-27K</b>	<b>900L</b> <b>1200L</b> <b>1500L</b> <b>2000L</b> <b>3000L</b> <b>4000L</b>	<b>90+</b>	<b>NSPD</b> <small>Narrow Spot (15°)</small> <b>SPD</b> <small>Spot (24°)</small> <b>ND</b> <small>Narrow (30°)</small> <b>MD</b> <small>Medium (36°)</small> <b>MWD</b> <small>Medium Wide (52°)</small> <b>WD</b> <small>Wide (60°)</small> <b>VWD</b> <small>Very Wide (70°)</small>	<b>DIM10</b> <b>DMX-512</b> <b>DMX-RDA</b> <b>DALI</b> <b>BLE</b> <b>LUTH</b>	<b>120V</b> <b>277V</b> <b>MVOLT</b>	- <b>EMG-LED-10W</b> <b>EMG-LED-20W</b> <b>INTG-EMG-LED-10W</b> <b>INTG-EMG-LED-20W</b> <b>EMG-LED-G2-10W-SI</b>	- <b>CP</b> <b>USA</b>	- <b>EC-WC-TWH-HW-MVOLT</b> <small>Dual-channel touch screen wall controller with tunable white technology, supporting 0-10V dimming.</small>

**1** For DIM10 driver you must dedicate two control inputs, one for the Dimming Control and another for CCT Tuning    **2** Lutron is the T-Series 2-Channel Tunable White EcoSystem

PART NUMBER: **EPD-8-RGBW-LENGN-65K-18K-1100L-90-NSPD-ELDODMX.1-120V**

Series	Technology	Lumens	CRI	Optics	Driver	Voltage	Emergency	Options
<b>EPD-8-RGBW</b> <small>(RGB + White)</small>	<b>LENGN-65K-18K</b>	<b>1100L</b> <b>2000L</b>	<b>90+</b>	<b>NSPD</b> <small>Narrow Spot (15°)</small> <b>SPD</b> <small>Spot (24°)</small> <b>ND</b> <small>Narrow (30°)</small> <b>MD</b> <small>Medium (36°)</small> <b>MWD</b> <small>Medium Wide (52°)</small> <b>WD</b> <small>Wide (60°)</small> <b>VWD</b> <small>Very Wide (70°)</small>	<b>ELDODMX.1</b>	<b>120V</b> <b>277V</b> <b>MVOLT</b>	- <b>PELI-S-20</b> <b>PELI-S-100</b> <b>PELI-S-250</b> <b>PELI-S-400</b>	- <b>CP</b> <b>USA</b>

**Note:** All extra optical accessories, aperture assemblies, and optics can be ordered separately. Check EPL Website for ordering nomenclature.

















# 8"

## Architectural LED Downlight

# EPD-8-RGBW

## Edison Series

### ORDER GUIDE

REFLECTOR TYPE				MOUNTING	COLOR									
REFLECTOR TYPE				MOUNTING	COLOR									
				<b>ANODIZED FLANGED</b>										
Open Downlight EPD-8-801	Wall Wash EPD-8-807	Double Wall Wash EPD-8-877	Corner Wall Wash EPD-8-827	Flanged	Clear White CL-WH	Clear Bronze CL-BZ	Black White BK-WH	Satin Haze SHZ-SHZ	Wheat WT-WT					
														
				<b>ANODIZED TRIMLESS</b>										
Open Downlight EPD-8-TL-801	Wall Wash EPD-8-TL-807			Trimless	White WH	Black BK	Clear CL	Satin Haze SHZ						
														

# 8"

## Architectural LED Downlight

# EPD-8-RGBW

## Edison Series

### Modifications Available

Consult factory for modification requests; orders may require shop drawing approval.

### Downlight

Our signature anodized reflector, spun to a reverse parabola design, achieves a 50° shielding angle and a 40° cut-off, which eliminates inter-reflections, and enhances low aperture brightness

### Wall Wash

The optical assembly delivers uniform ceiling-to-floor wallwashing without creating any visible scallops. The optical assembly is specially designed to extend a beam in two directions for a uniform floor-to-ceiling and side-to-side wash of light.

### Double Wall Wash

Used in a corridor to wash both walls, providing both horizontal and vertical illumination that fully illuminates corridors and hallways.

### Corner Wall Wash

Replacing the effect that two luminaires provide, a corner wallwasher kicks light across corners that run perpendicular to one another, ultimately providing a 210° wash of light fully covering conjoined walls and surfaces.

### Optical Performance and Trim

Spun aluminum anodized single piece reflector. The optical system consists of 1) an upper reflector for a precise beam spread; 2) a solite soft focus lens to diffuse the light source for smooth, striation-free distribution; 3) and a patented lens to control the beam angle and provide a 40° visual cutoff. Available in a variety of beam angles. Integral heatsink comes preinstalled on the housing for maximum heat dissipation and locks together with the reflector to prevent zero light leakage for above the ceiling.

### Fully Servicable - Easy Installation & Upgrading

Housing maybe installed in ceilings of up to 1-1/2 inch thickness without the use of additional collars. Torsion springs on EPCh side of the reflector hold snug to the ceiling, and allows for fast, easy installation into housing, and fast removal for easy access to the junction box from below the ceiling.

### Trim Design

Luminaire is designed for installation in sheetrock or T-Bar ceilings to achieve a flush trim detail.

- Trimless option has a perforated face. Installation includes the application of drywall compound over the luminaire's integral spackle screen to the rim of its integral plaster ring.

### Housing / Mounting

16-gauge steel, preassembled one-piece construction with integral 27" C-channel mounting brackets included. Mounting brackets may be adjusted up to 28" horizontally, and 2-3/4" vertically, and locking into place.

### Emergency Options/Controls

The test switch for the emergency battery can be installed on the side of the reflector (integral INTG-EMG option), or the test switch can be mounted remotely (EMG-LED option). Self Diagnostic emergency option available (EMG-SDT-LED-10W) Typical lumen output of the luminaire is up to 1000L with EMG-LED-10W or INTG-EMG-LED-10W option & 2000L with EMG-LED-20W or INTG-EMG-LED-20W option in emergency mode. Other accessories and controls systems include modular wiring systems, daylight harvesting controls, occupancy sensors, and/or power packs for individual or room control applications.

### Drivers

RGB+White platform with tuning range of 6500K to 1650K, Saturation and Hue Gradients of color can be added in increments of 1% to fully saturated colors at 100% enabling gamut access to pastels and saturated colors (RGBW- 65K-16K). Control via, DMX-512/RDM.

### Tunable White Option

Tunable White allows the luminaires to be color tuned via various controls. Create the perfect environment for the desired use of the space or mimic the natural color patterns throughout the day and stimulate circadian rhythm. Available in tuning range of 50K-27K (TWH-50K-27K), 65K-27K (TWH-65K-27K), 65K-18K (TWH-LENGN-65K-18K).

### RGB + White Option

Refine your space with Mood Master (RGBW & TW), which provides complete control over hue, color temperature, saturation, and dimming for design versatility. RGB + White technology has a white color tuning range from 6500K to 1650K. RGB color range derived from the primary colors red, green and blue is used to create infinite color options in the RGB palette, adding colors together in varying amounts to create new ones. RGB Tunable White technology enables users to adjust the color temperature, adding gradients of saturated colors. No longer restricted to white light LEDs, lighting designers and architects can manipulate a space with desired hues and shades, altering the color temperature of the room, creating the perfect environment. The use of RGB Tunable White technology in allows infinite possibilities for any application

### Dimming & Driver Information

**DIM10** - 0-10V dimming on either MVOLT 120, 277 or 347V. Dimmable down to 1% of initial lumens, standard

**DMX-512** - EldoLED PowerDrive dimming down to 0.1%. Please see EldoLED website for wiring diagrams and a list of compatible DMX and DALI control systems.

**DMX-RDM** - EldoLED PowerDrive dimming down to 0.1%. Please see EldoLED website for wiring diagrams and a list of compatible DMX and DALI control systems.

**DALI** - EldoLED SoloDrive DALI-2. Dimming down to 0.1%

**BLE** - Bluetooth Casambi enabled controllable

**LUTH** - Lutron LDE1 Hi-Lume Eco System with Soft Fade to Black 1% dimming

**ELDODMX.1** - EldoLED PowerDrive dimming down to 0.1%. Please see EldoLED website for wiring diagrams and a list of compatible DMX and DALI control systems.



# 8"

## Architectural LED Downtlight

# EPD-8-RGBW

## Edison Series

### FLANGED

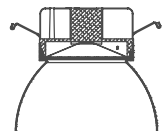
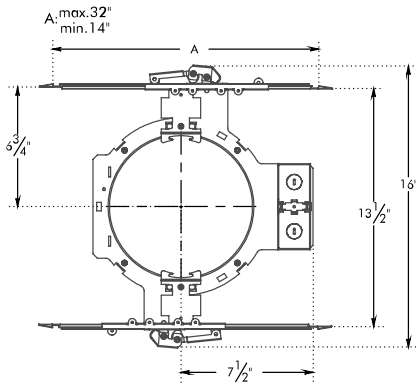
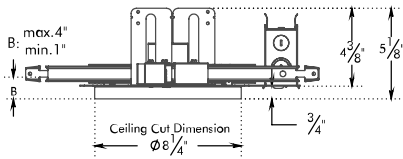
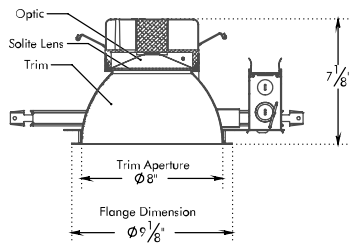
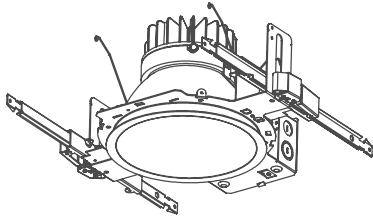

Downlight

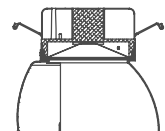

Wall Wash

### TRIMLESS

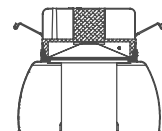
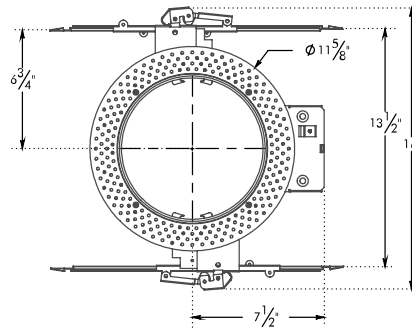
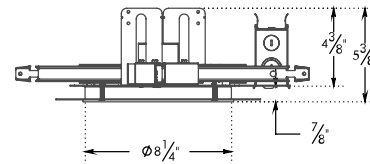
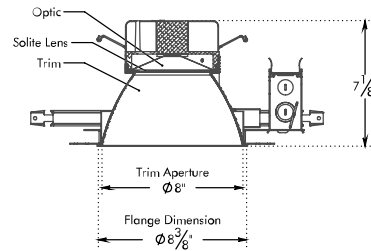
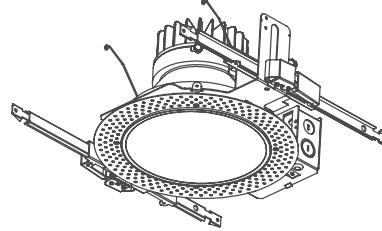

Double Wall Wash

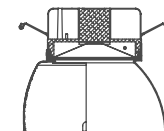

Corner Wall Wash